

TOPMATIC 313A/A1

POTAIN 

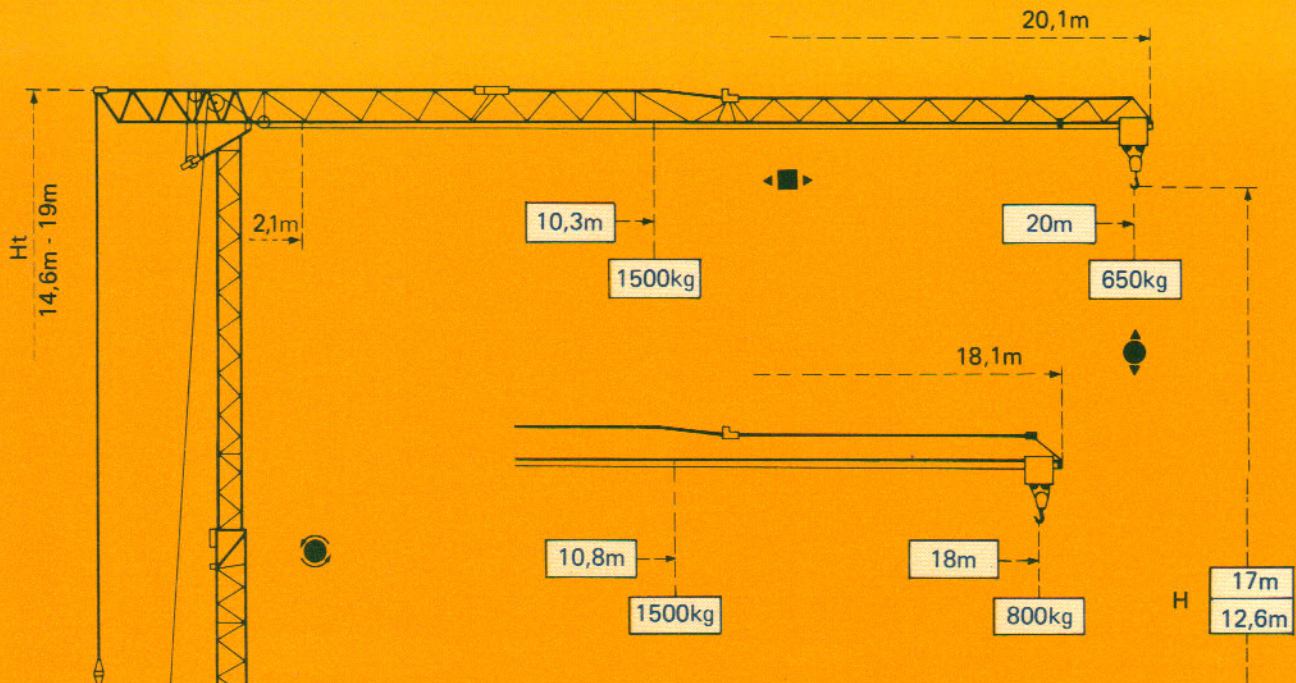

Version A sur vérins
Ausführung A auf Abstützspindeln
Jacks version A
Versión A sobre gato

Version A voie droite
Ausführung A gerade Schienenbahn
Straight track version A
Versión A via recta

Version A1 sur vérins
Ausführung A1 auf Abstützspindeln
Jacks version A1
Versión A1 sobre gato

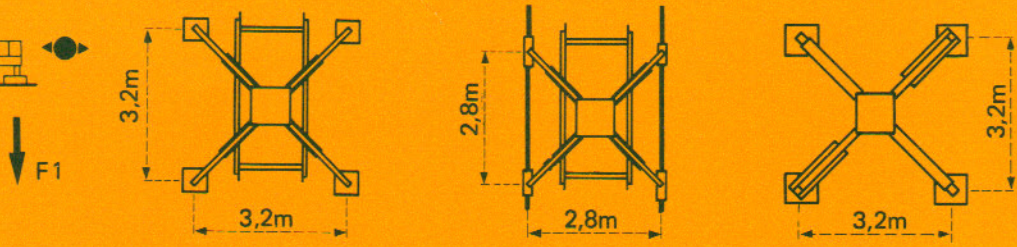

F1 = Réactions Eckdrücke Reactions Reacciones

F1	● 86,7 kN	■ 58,9 kN
	5,6 t	

- En service
- Hors service

 A vide sans lest ni train de transport, avec flèche et hauteur maximum.

- In Betrieb
- Ausser Betrieb

 Ohne Last, Ballast und Transportachse, mit Maximalausleger und Maximalhöhe.

- In service
- Out of service

 Without load, ballast or transport axles, with maximum jib and maximum height.

- En servicio
- Fuera de servicio

 Sin carga, sin lastre, ni tren de transporte, flecha y altura máximas.

Courbes de charges Lastkurven Load diagram Curvas de cargas

 Flèche Ausleger Jib Flecha

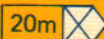
2 →	10,3	11	12	13	14	15	16	17	18	19	20	m
	1500	1370	1230	1120	1020	940	860	800	740	690	650	kg

2 →	10,8	11	12	13	14	15	16	17	18	m
	1500	1470	1320	1200	1090	1000	930	860	800	kg

Flèche relevée Ausleger in Steilstellung Luffing jib Flecha izada



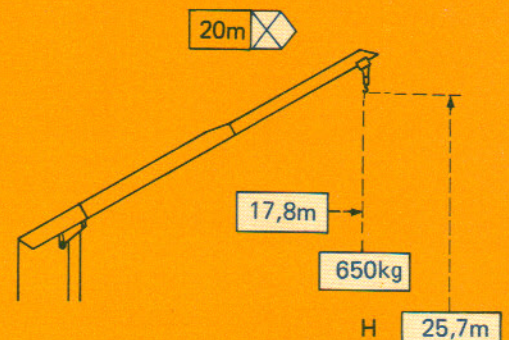
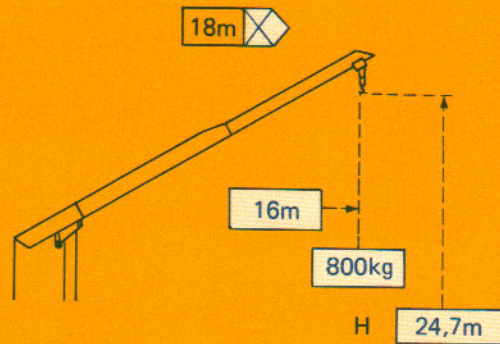



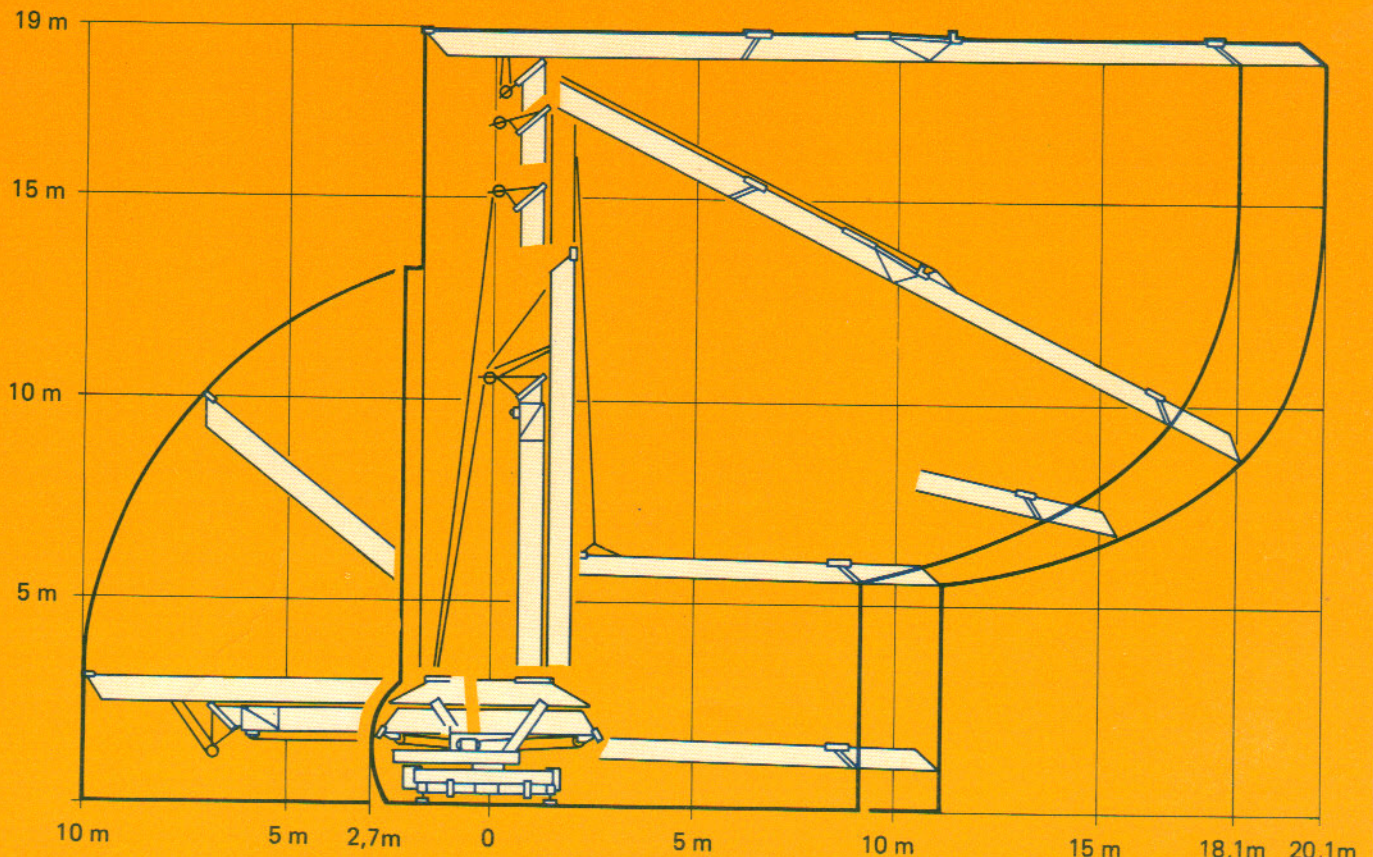





Chariot bloqué
(version standard)
Verriegelte Laufkatze
(Standardausführung)
Trolley locked
(standard crane)
Carro bloqueado
(version standard)



Montage Montage Erection Montaje



Mécanismes Antriebe Mechanisms Mecanismos

			m/min.	kg	ch-PS hp	kW
Levage Heben Hoisting Elevación	S1 		20	1500	6,5	5
			40	750		
			5	1500	1,6	1,2
			20	1500	6,5	5
			40	750		
Distribution - Katzfahren Trolleying - Distribución		DV10	30		1,5	1
Orientation - Schwenken Slewing - Orientación		MCS10	0,3 - 1 tr/min U/min-rpm		1	0,8
Translation - Kranfahren Travelling - Traslación		TVD221	30		2 x 1,5	2 x 1
Puissance électrique nécessaire Anschlusswert Necessary electric power Potencia eléctrica necesaria	380 V 50 HZ 	Réseau - Netzstrom Mains supply - Red			16 kVA	
		Groupe électrogène Stromaggregat Generator set Grupo electrogeno			Nous consulter Auf Anfrage Consult us Consultarnos	

Transport Transport Transport Transporte

Version A : grue avec 2 essieux débrochables tractée derrière camion
 Ausführung A : Kran mit 2 abnehmbaren Standardtransportachsen als LKW-Anhänger
 Version A : Crane with 2 removable axles towed behind lorry
 Version A : Grua con 2 ejes de transporte desmontables remolcada con camión

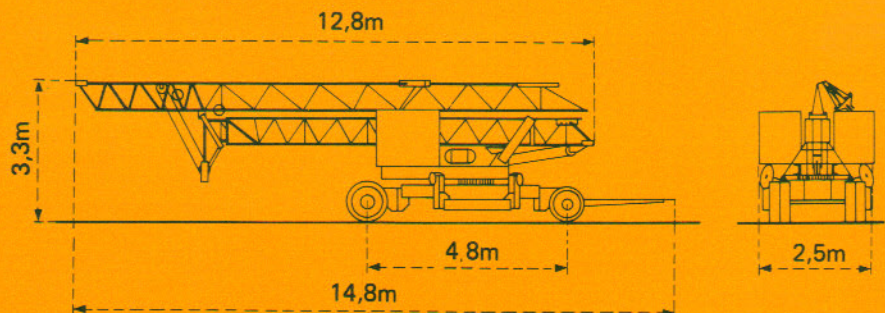

Version A1 : grue avec 1 essieu fixe tractée derrière camion
 Ausführung A1 : Kran mit 1 fest angebaute Transportachse als LKW-Anhänger
 Version A1 : Crane with 1 fixed axle towed behind lorry
 Version A1 : Grua con 1 eje fijo remolcada con camión

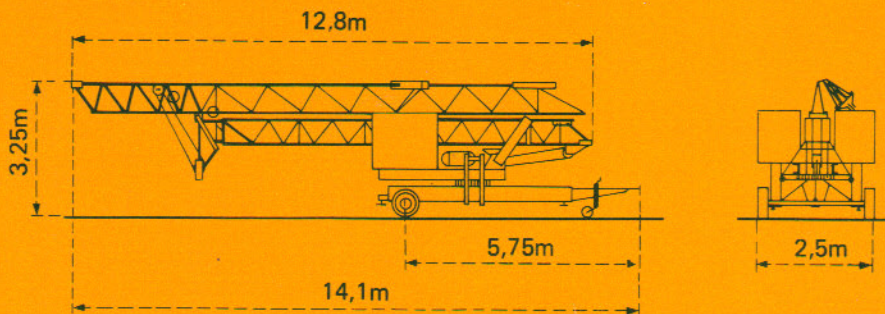

DIN 15018 H1 B3

POTAIN

18, rue de Charbonnières B.P. 173 - 69132 ECULLY Cedex
 Tél. (7) 833.81.81 - Télex 330 179
 DIRECTION DES ACTIVITES INTERNATIONALES
 207, rue de Bercy - 75012 PARIS
 Tél. (1) 347.30.77 - Télex 215 483
 POTAIN GmbH - D 6082 MÖRFELDEN - WALLDORF
 Nordendstr. 79-87 - Postfach 420 - Tel. 6105 704.0 - Telex 4.185745
 POTAIN SUISSE S.A. - CH 5115 MÖRIKEN WILDEGG
 Tel. 64.53.19.91 - Telex 68294

Ref. 8036 EYC 6

Modifications réservées - Änderungen vorbehalten - Subject to modification - Modificaciones reservadas

Printed in France