

---

**GMH 519**

---

**POTAIN**   
**FERGRU**

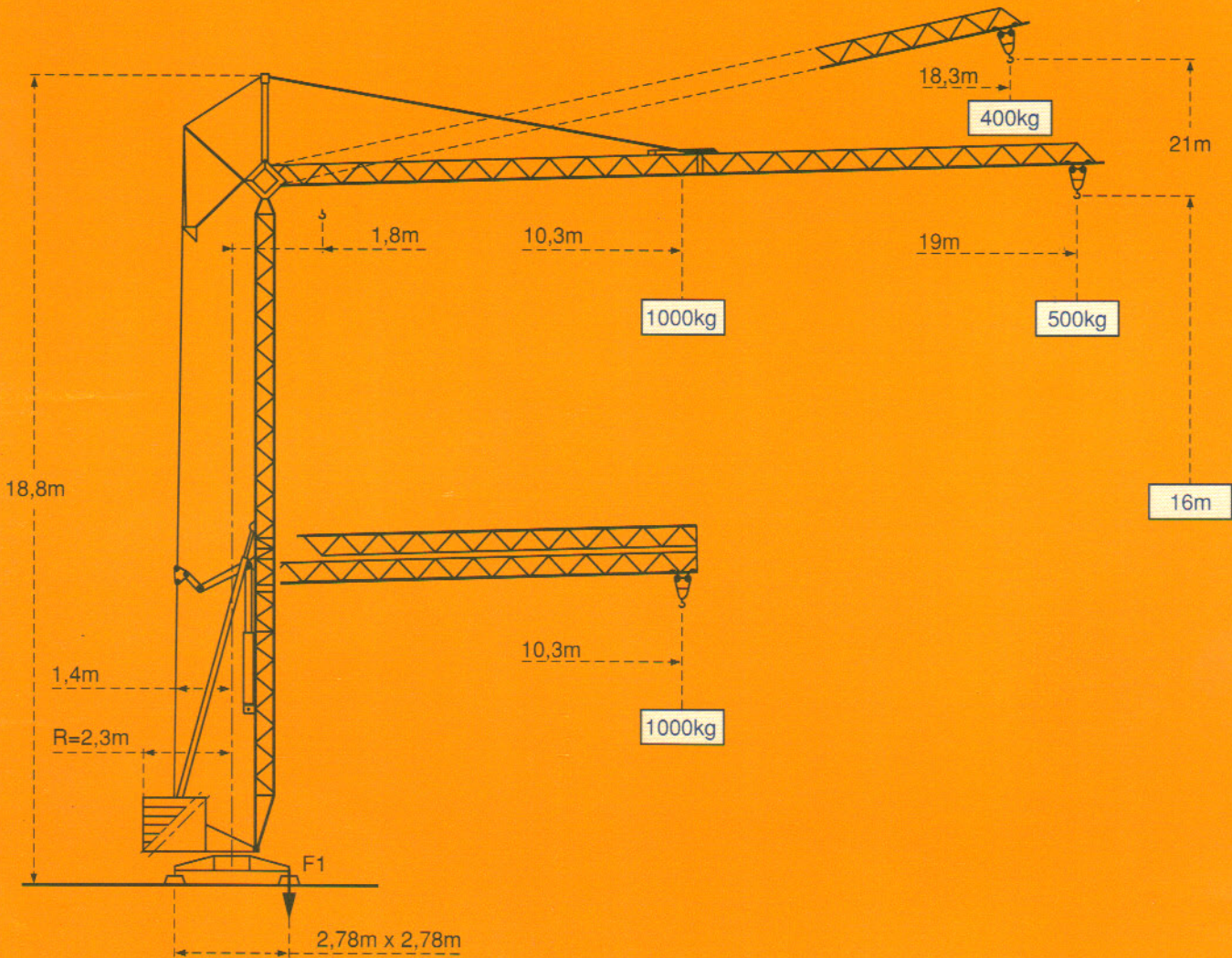

**F1 = Réactions Eckdrücke Reactions Reacciones Reazioni**

F1	● 7,1 t	■ 5,1 t
	5 t	

● En service  
■ Hors service

● In Betrieb  
■ Ausser Betrieb

● In service  
■ Out of service

● En servicio  
■ Fuera de servicio

● In servizio  
■ Fuori servizio

A vide sans lest ni train de transport, avec flèche et hauteur maximum.

Ohne Last, Ballast und Transportachse, mit Maximalausleger und Maximalhöhe.

Without load, ballast or transport axles, with maximum jib and maximum height.

Sin carga, sin lastra, ni tren de transporte, flecha y altura máximas.

A vuoto, senza zavorra ne assali di trasporto con braccio massimo e altezza massima.

**Courbes de charges    Lastkurven    Load diagrams**  
**Curvas de cargas    Curve di carico**



Flèche    Ausleger    Jib    Flecha    Braccio

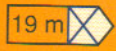

	10,3	12	13	14	15	16	17	18	19	m
19 m	1000	845	770	710	655	610	570	530	500	Kg

**Flèche relevée    Ausleger in Steilstellung    Luffing jib**  
**Flecha izada    Braccio impennato**



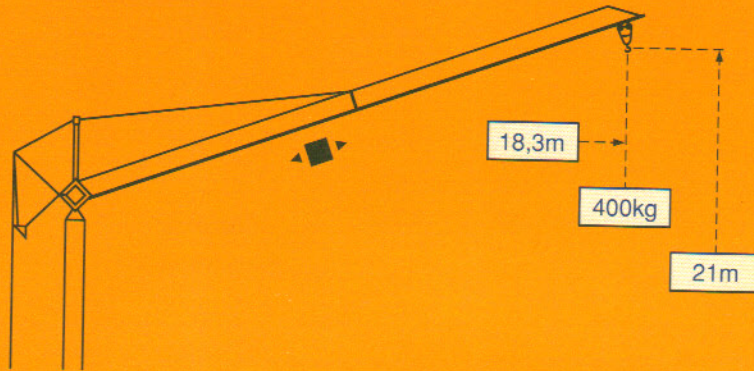

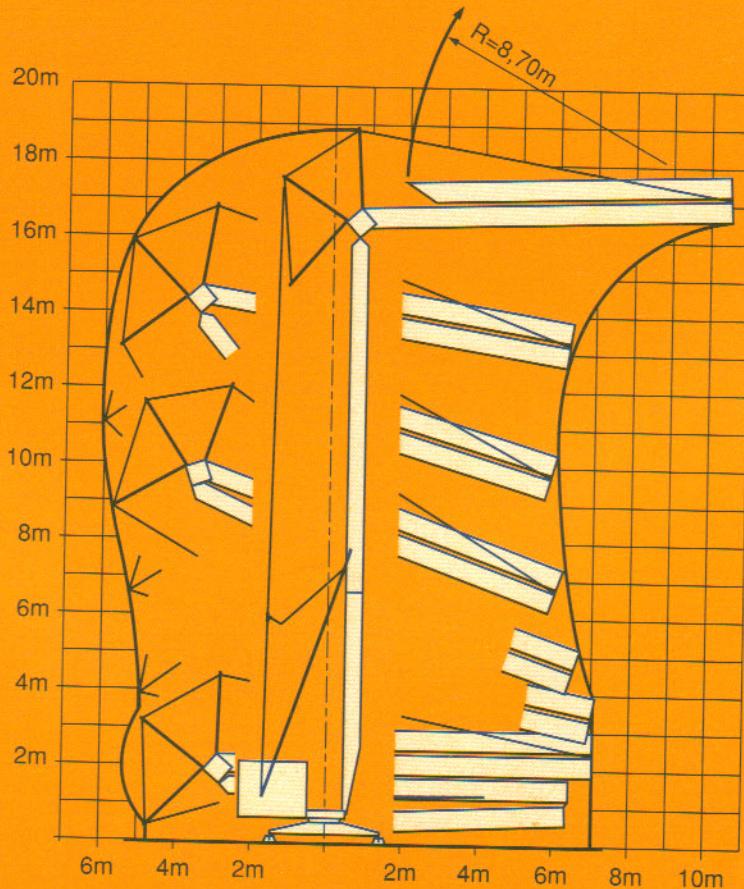

◀ ■ ▶  
 Chariot distributeur  
 Verfahrbare Laufkatze  
 Traversing trolley  
 Carro distribuidor  
 Carrellino distributore



**Montage    Montage    Erection    Montaje    Montaggio**



Mécanismes    Antriebe    Mechanisms    Mecanismos    Meccanismi

				m/min	kg	ch-PS hp	kW
Levage Heben Hoisting Elevación Sollevamento		220V		11,2	1000	2,2	1,6
				22,5	500	2,2	1,6
		380V		14	1000	4	2,9
				28	500	5	3,6
Distribution - <i>Katzfahren</i> - Trolleying Distribución - Distribuzione				30		1,5	1,1
Orientation - <i>Schwenken</i> - Slewing Orientación - Rotazione				1 tr/min U/min-rpm		1	0,7
Réseau - <i>Netzstrom</i> - Mains supply - <i>Red</i> - Reta elettrica						220 V 50 Hz	380 V 50 Hz
Puissance électrique nécessaire - <i>Anschlusswert</i> - Necessary electric power <i>Potencia eléctrica necesaria</i> - Potenza elettrica necessaria						5 kVA	8 kVA
Groupe électrogène - <i>Stromaggregat</i> - Generator set - <i>Grupo electrogeno</i> - Gruppo elettrogeno						*	

\* Nous consulter - *Auf Anfrage* - Consult us - *Consultarnos* - Consultateci

Transport    Transport    Transport    Transporte    Trasporto

DS65/S65

DS50/S50

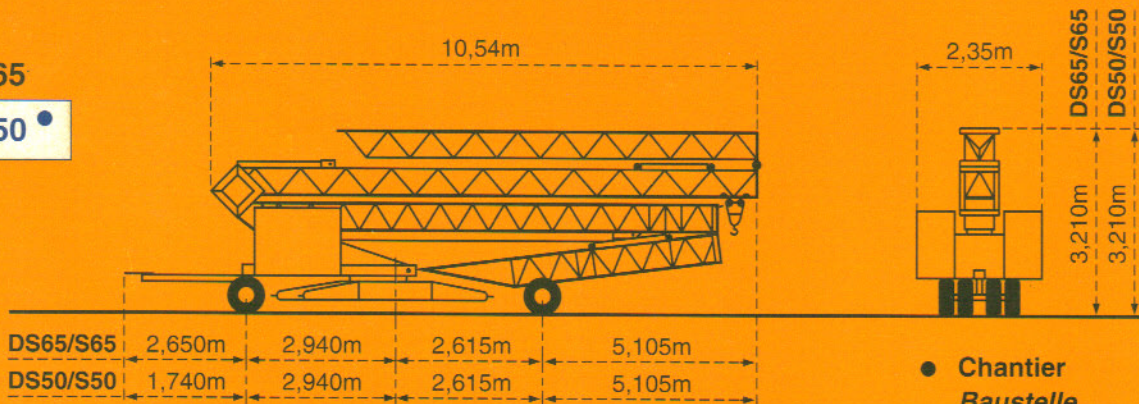

- Chantier  
Baustelle  
Site  
Obra  
Cantiere

Conforme à la directive CEE 84/534 sur le niveau acoustique - *Gemäss EWG-Richtlinie 84/534 über Schall-Leistungspegel*  
 In compliance with the EEC 84/534 Instruction on noise level - *Conforme con la direttiva CEE 84/534 sobre el nivel acustico*  
 Conforme colla direttiva CEE 84/534 sul livello acustico.

NF E 52081 - 82

DIN 15018.H1 B3

**POTAIN** 

18, rue de Charbonnières, B.P. 173-F 69132 ECULLY Cedex  
 Tél. 72.20.20.20 - Télex 330 179 - Télex. Export 375 213 -  
 Fax 72.20.20.00

POTAIN GmbH 6082 MÖRFELDEN WALLDORF  
 Nordendstr. 79-87 - Postfach 420  
 Tél. 06 105 704.0 - Télex 4.1857 45

GMH 519

Ref. 1990 - 43 - LAX 4

Modifications réservées - Änderungen vorbehalten - Subject to modification - Modificaciones reservadas - Modifiche riservate

Printed in France

Réalisation SODIPE